

ESC 81 LED EMERGENCY EXIT LIGHT TWT8153WA

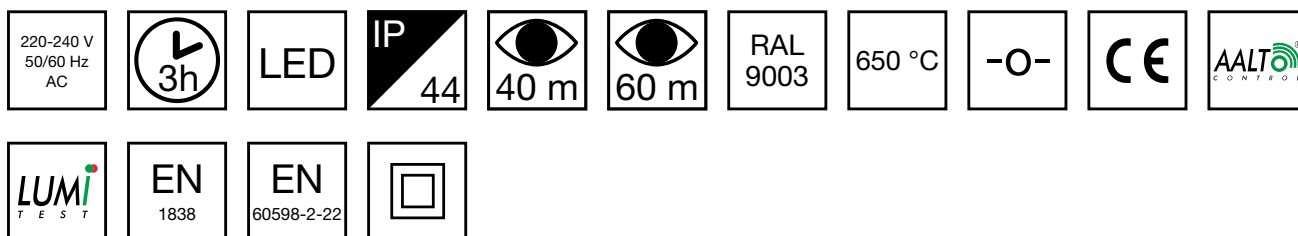

Self-contained LED Emergency Exit Light with 3 h Battery and Wireless Central Monitoring

ESC 81 is an innovative LED exit light equipped with a light plate. It combines cutting edge technology with modern luminaire design.

Evenly illuminated light plates, low power consumption and slender looking luminaires are the result of Teknoware's pioneering, expertise in electronics and product design. Luminaire can be used as 1 or 2 sided, recess and surface mounted.

ESC 81 is particularly easy and fast to install thanks to a separate mounting piece, into which also the power supply is connected.

We reserve the rights to make modifications without notice.

Copyright © 2024 Teknoware. All rights reserved.

Date: August 14, 2024 | Source: [teknoware.com/en/emergency-lighting/esc-81-led-emergency-exit-light-twt8153wa](https://www.teknoware.com/en/emergency-lighting/esc-81-led-emergency-exit-light-twt8153wa)



Teknoware Oy | P.O. Box 19, 15101 Lahti | Ilmarisentie 8, 15200 Lahti Finland
Tel +358 3 883 020 | VAT-number FI01494751 | [teknoware.com](https://www.teknoware.com) | emexit@teknoware.com

INDIVIDUALLY PACKED LIGHTS

Product Code
Y8153WA153
Y8153WA158
Y8153WA157
Y8153WA155
Y8153WA159
Y8153WA151
Y8153WA152
Y8153WA163
Y8153WA168
Y8153WA167
Y8153WA165
Y8153WA169
Y8153WA161
Y8153WA162

Product Code	TWT8153WA
Feature	Aalto Control, Lumi Test
Mounting (standard)	ceiling, wall
Mounting (optional)	recess, flag, pendel
Customs Code	94056080
GTIN Code	6438045011929
ETIM Product Class	EC001957
Length	405 mm
Width	40 mm
Height	287 mm
Weight	2,1 kg

We reserve the rights to make modifications without notice.

Copyright © 2024 Teknoware. All rights reserved.

Date: August 14, 2024 | Source: teknoware.com/en/emergency-lighting/esc-81-led-emergency-exit-light-twt8153wa

Teknoware Oy | P.O. Box 19, 15101 Lahti | Ilmarisentie 8, 15200 Lahti Finland
Tel +358 3 883 020 | VAT-number FI01494751 | teknoware.com | emexit@teknoware.com











Backup	3 h
Max Input Power VA	4,5 VA
Nominal Supply Voltage	220-240 V, 50/60 Hz AC
Protection Class	II
IP Class	IP44
Temperature Range Min - Max	-5...+30 °C
Glow Wire Test of Plastic Materials	650 °C
Viewing Distance	40/60 m
Light Source	LED
Body Material	plastic
Aperture for Recess Mounting	53 x 415 mm
Colour	RAL9003
Electrical Installation	2/3 x 2,5 mm ²

ONE OR MORE OF THESE IS ALSO REQUIRED:

PICTOGRAMS FOR EMERGENCY EXIT LIGHTS



Product Code	Pictogram	Viewing Distance (m)	Compatible Product Groups
PBV81402E		40	ESC 81 Emergency Exit Lights
PBV81402E3		40	ESC 81 Emergency Exit Lights
PBV81401E		40	ESC 81 Emergency Exit Lights
PBV81401E1		40	ESC 81 Emergency Exit Lights
PBV81401E2		40	ESC 81 Emergency Exit Lights
PBV81602E		60	ESC 81 Emergency Exit Lights
PBV81601E		60	ESC 81 Emergency Exit Lights
PBV81601E1		60	ESC 81 Emergency Exit Lights
PBV81601E2		60	ESC 81 Emergency Exit Lights

We reserve the rights to make modifications without notice.

Copyright © 2024 Teknoware. All rights reserved.

Date: August 14, 2024 | Source: [teknoware.com/en/emergency-lighting/esc-81-led-emergency-exit-light-twt8153wa](https://www.teknoware.com/en/emergency-lighting/esc-81-led-emergency-exit-light-twt8153wa)



OPTIONAL ACCESSORIES:

SHOCK PROTECTING COVERS FOR EMERGENCY LIGHTS



Product Code	Product Name	Compatible Product Groups
TW77510B	Shock protecting cover TW77510B	ESC 10 Emergency Exit Lights, DISCONTINUED: ESC 6L Emergency Exit Lights, ESC 29 Emergency Exit Lights, Safe 29 Emergency Lights, ESC 81 Emergency Exit Lights

COVER LABELS FOR EMERGENCY EXIT LIGHTS



Product Code	Pictogram	Compatible Product Groups
XWT8101		ESC 81 Emergency Exit Lights
XWT8106		ESC 81 Emergency Exit Lights

OPTIONAL MOUNTING ACCESSORIES FOR EMERGENCY EXIT LIGHTS



Product Code	Product Name	Compatible Product Groups
TWT9000	Suspension bracket TWT9000	ESC 90 Emergency Exit Lights, ESC 80 Emergency Exit Lights, ESC 81 Emergency Exit Lights
TWT8101B	Recess mounting frame TWT8101B	ESC 81 Emergency Exit Lights
TWT8102	Flag bracket TWT8102	ESC 81 Emergency Exit Lights

SPARE PARTS:

SPARE PARTS FOR EMERGENCY LIGHTS



Product Code	Product Name	Compatible Product Groups
W120011	Battery package W120011	TKT66C Central Battery Systems, TKT67C Central Battery Systems, ESC 90 Emergency Exit Lights, ESC 81 Emergency Exit Lights, ESC 80 Emergency Exit Lights

We reserve the rights to make modifications without notice.

Copyright © 2024 Teknoware. All rights reserved.

Date: August 14, 2024 | Source: [teknoware.com/en/emergency-lighting/esc-81-led-emergency-exit-light-twt8153wa](https://www.teknoware.com/en/emergency-lighting/esc-81-led-emergency-exit-light-twt8153wa)

Teknoware Oy | P.O. Box 19, 15101 Lahti | Ilmarisentie 8, 15200 Lahti Finland
Tel +358 3 883 020 | VAT-number FI01494751 | [teknoware.com](https://www.teknoware.com) | emexit@teknoware.com



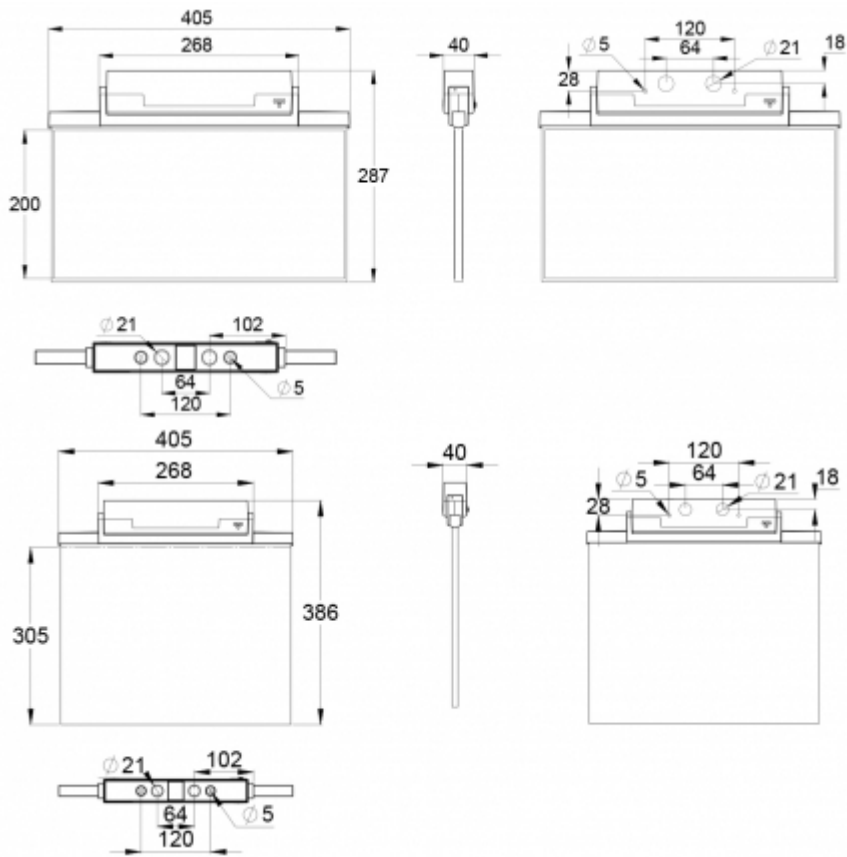

We reserve the rights to make modifications without notice.

Copyright © 2024 Teknoware. All rights reserved.

Date: August 14, 2024 | Source: teknoware.com/en/emergency-lighting/esc-81-led-emergency-exit-light-twt8153wa

Teknoware Oy | P.O. Box 19, 15101 Lahti | Ilmarisentie 8, 15200 Lahti Finland
 Tel +358 3 883 020 | VAT-number FI01494751 | teknoware.com | emexit@teknoware.com

